

# LANDSCAPE PLANS

MARCO ISLAND, FL, SITE DEVELOPMENT PLANS  
for

# BARGAIN BASKET MARCO ISLAND

Reviewed for code compliance  
M Holden  
12/18/2024 12:18:42 PM



GradyMinor  
Civil Engineers  
Landscape Architects  
Land Surveyors  
Planners

Bonita Springs 239.947.1144  
Fort Myers 239.690.4380

www.GradyMinor.com

Richard P. Chalupa, RLA

Digitally signed  
by Richard P.  
Chalupa, RLA  
Date:  
2024.11.04  
14:30:53 -05'00'

License No. 6667463

Owner/Developer:

**United Church of Marco Island**  
750 Bald Eagle Drive  
Marco Island, FL 34145  
Tel: 239-394-6640

COLLIER COUNTY FOLIO NUMBER: 57991200001

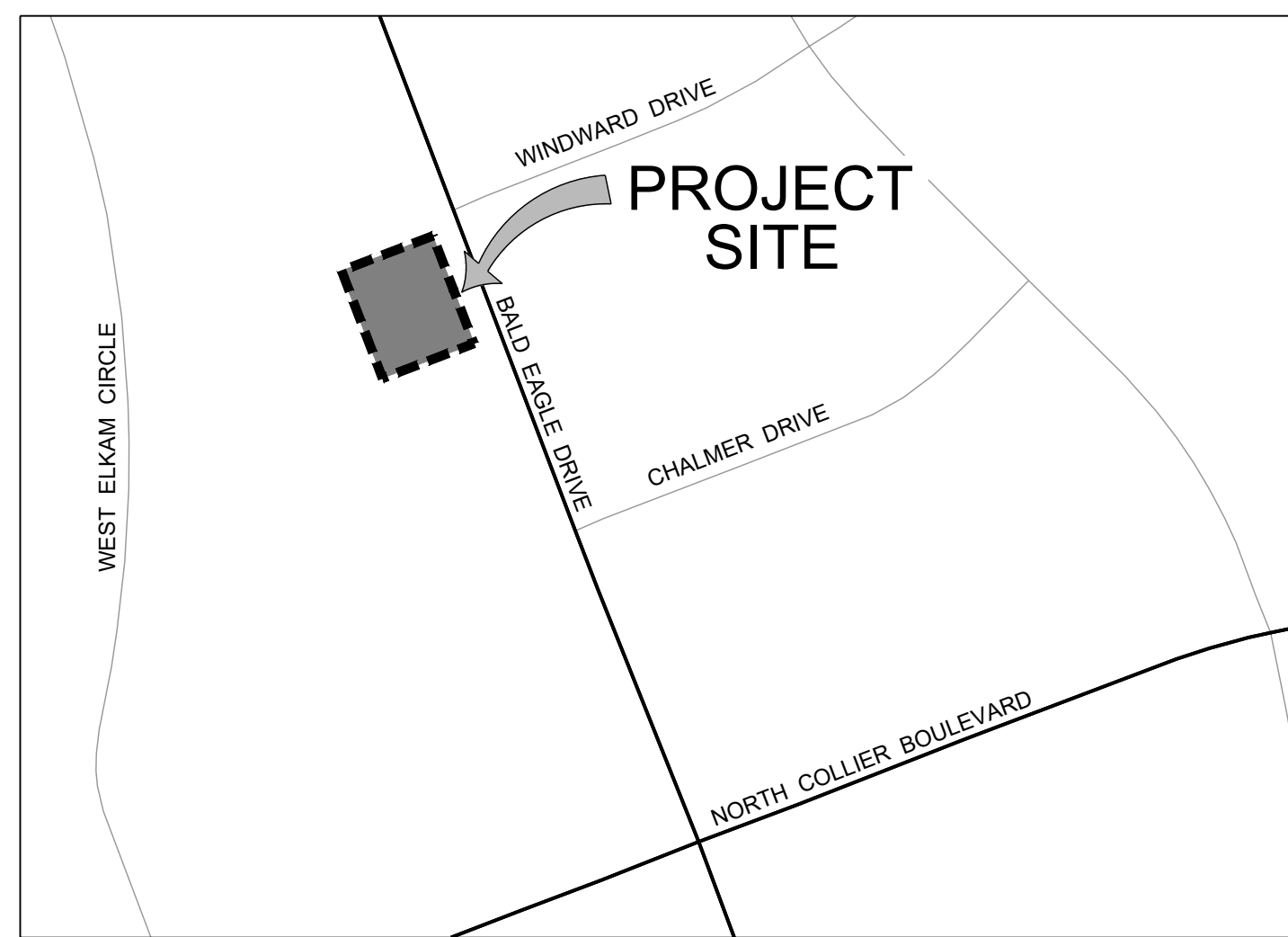

VACINITY MAP  
SCALE: 1" = 300'

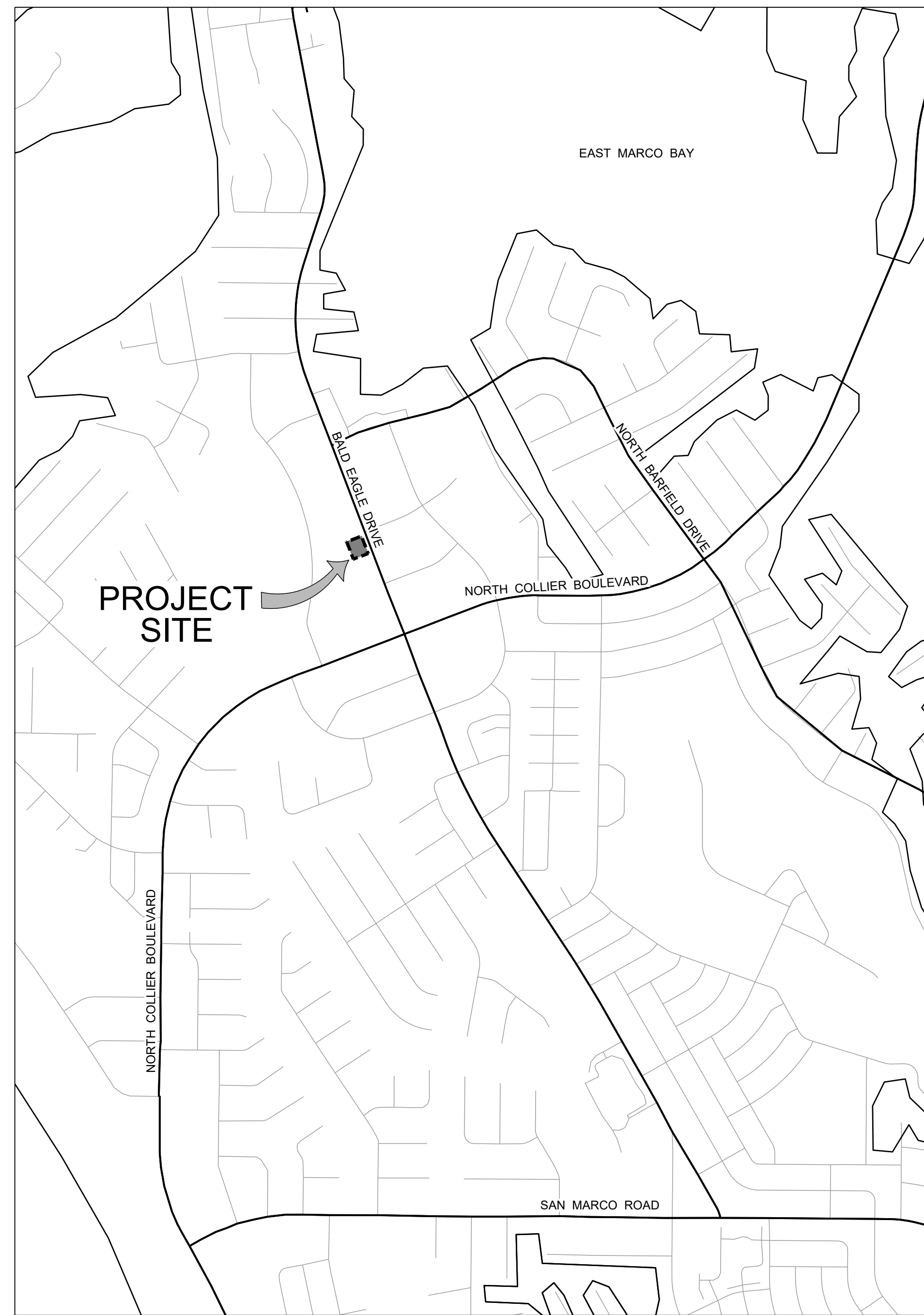
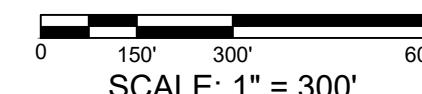

LOCATION MAP  
SCALE: 1" = 1000'

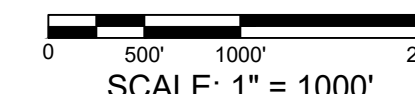

LANDSCAPE ARCHITECTURAL PLANS	
TABLE OF CONTENTS	
Dwg. No.	Description
1	COVER SHEET
2	SDP LANDSCAPE PLAN
3	LANDSCAPE CALCS & PLANT SCHEDULE
4	DETAILS SHEET

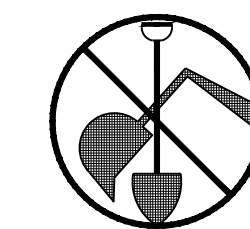

INVESTIGATE  
BEFORE YOU  
EXCAVATE



"CALL SUNSHINE"  
1-800-432-4770

TOLL FREE

FL STATUTE 553.851 (1979) REQUIRES  
MIN. OF 2 DAYS AND MAX. OF 5 DAYS  
NOTICE BEFORE YOU EXCAVATE.



BARGAIN BASKET MARCO ISLAND  
COVER SHEET  
MARCO ISLAND, FL

REVISIONS

NO.	DATE	DESCRIPTION

SHEET  
1 OF 4

DATE: SEPTEMBER 2024

G:\LANDSCAPE\WV\LAB-BARGAIN BASKET\DWG\SDP\LAB-B-SDP-LA-DWG-10/22/2024 12:50 PM





**GradyMinor**  
Civil Engineers  
Landscape Architects  
Land Surveyors  
Planners

Bonita Springs 239.947.1144  
Fort Myers 239.690.4300

www.GradyMinor.com

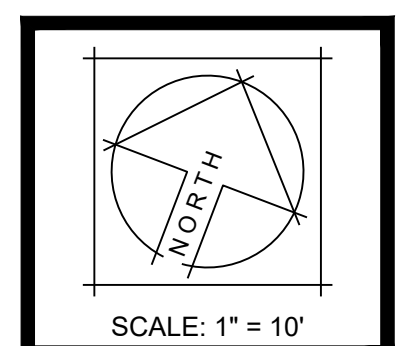
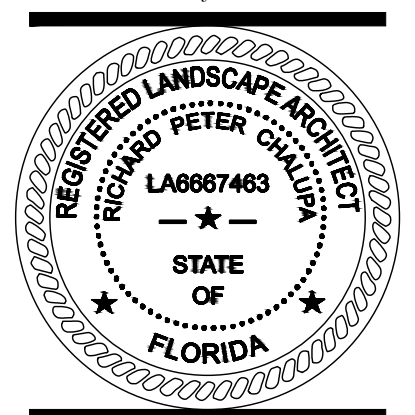

# BARGAIN BASKET MARCO ISLAND

## SDP LANDSCAPE PLAN

### MARCO ISLAND, FL

G:\LANDSCAPE\BARGAIN BASKET MARCO ISLAND\BARGAIN BASKET SDP\DWG\10222024\12.51.PLM

REVISIONS

**SHEET**  
**2 OF 4**

DATE: SEPTEMBER 2024

**ABBREVIATION LEGEND:**

CALLOUT	DESCRIPTION
VUA	REQUIRED VEHICULAR USE TREE
RBT	REQUIRED BUFFER TREE
BLD	REQUIRED BUILDING TREE
RGT	REQUIRED GENERAL TREE
RST	REQUIRED SHADE TREE
EOW	EDGE OF WATER
EOP	EDGE OF PAVEMENT
BOC	BACK OF CURB
UE	UTILITY EASEMENT
DE	DRAINAGE EASEMENT
LME	LAKE MAINTENANCE EASEMENT
LBE	LANDSCAPE BUFFER EASEMENT

**FPL UTILITIES NOTE:**  
ADHERE TO RECOMMENDED CLEARANCES FOR ALL FPL TRANSFORMERS / CABINETS:  
FRONT: 8'  
SIDES & REAR: 3'

**Utilities Standards Manual:**  
Trees are to be offset from Water Mains by 5 feet.

**EXISTING LANDSCAPE LEGEND:**

SYMBOL	BOTANICAL NAME	COMMON NAME	STATUS
	BURSERA SIMARUBA	GUMBO LIMBO	TO REMAIN
	QUERCUS VIRGINIANA	LIVE OAK	TO REMAIN
	PTYCHOSPERMA ELEGANS	ALEXANDER PALM, double	TO REMAIN
	PTYCHOSPERMA ELEGANS	ALEXANDER PALM, single	TO REMAIN
	ROYSTONEA ELATA	ROYAL PALM	TO BE REMOVED
	SABAL PALMETTO	CABBAGE PALM	TO BE REMOVED

**SPECIES TO BE REMOVED**

Botanical Name:	Common Name:
Abrus precatorius	Rosary Pea
Acacia auriculiformis	Earleaf Acacia
Albizia lebbek	Woman's Tongue
Araucaria heterophylla	Norfolk Island Pine
Bischofia javanica	Bishopwood
Casuarina spp.	Australian Pine
Colubrina asiatica	Lather Leaf
Cupianopsis anacardioides	Carrotwood
Dalbergia sissoo	Rosewood
Dioscorea alata	Winged Yam / Air Potato
Dioscorea bulbifera	Air Potato
Eucalyptus camaldulensis	Murray Red Gum
Ficus benjamina	Weeping Fig
Ficus microcarpa	Cuban Laurel Fig
Lantana camara	Lantana
Leucaena leucocephala	Lead Tree
Lygodium spp.	Climbing Fern
Melaleuca quinquenervia	Melaleuca
Mimosa pigra	Catclaw Mimosa
Panicum maximum	Guinea Grass
Rhodomyrtus tomentosa	Downy Rosemyrtle
Sapum sebiferum	Chinese Tallow
Scaevola taccada	Scaevola Beach Naupaka
Schinus terebinthifolius	Brazilian Pepper
Solanum viarum	Tropical Soda Apples
Syzygium cumini	Java Plum
Syzygium jambos	Rose Apple
Thespesia populnea	Seaside Mahoe
Urena lobata	Cassareed
Wedelia triobata	Wedelia

**PROHIBITED SPECIES LIST**

Botanical Name:	Common Name:
Cestrum diurnum	Day-blooming Jasmine
Eucalyptus camaldulensis	Murray Red Gum
Eugenia uniflora	Surinam Cherry
Ficus benjamina	Weeping Fig
Ficus microcarpa	Cuban Laurel Fig
Dalbergia sissoo	Rosewood
Koeleruteria elegans	Golden Raintree
Ligustrum lucidum	Glossy Privet
Ligustrum sinense	Chinese Ligustrum
Melia azederach	Chinaberry
Psidium cattleianum	Strawberry Guava
Psidium guajava	Common Guava
Sapum sebiferum	Chinese Tallow
Syzygium jambos	Rose Apple
Thespesia populnea	Cork Tree
Wedelia triobata	Wedelia

SEE ALSO, NOTE #14 IN THE LANDSCAPE INSTALLATION NOTES FOR ADDITIONAL EXOTIC PLANT RESOURCE(S).

**IRRIGATION LEGEND**

ZONE / VALVE LABEL: "H" or "L" for High or Low Water Use	
	# Irrigation Meter
	# Station Irrigation Controller
	Rain and Wind Sensor Switches
	Irrigation Valve
	Irrigation Main Line
	Sleeving Locations (See Irrigation Notes #4 & 5)

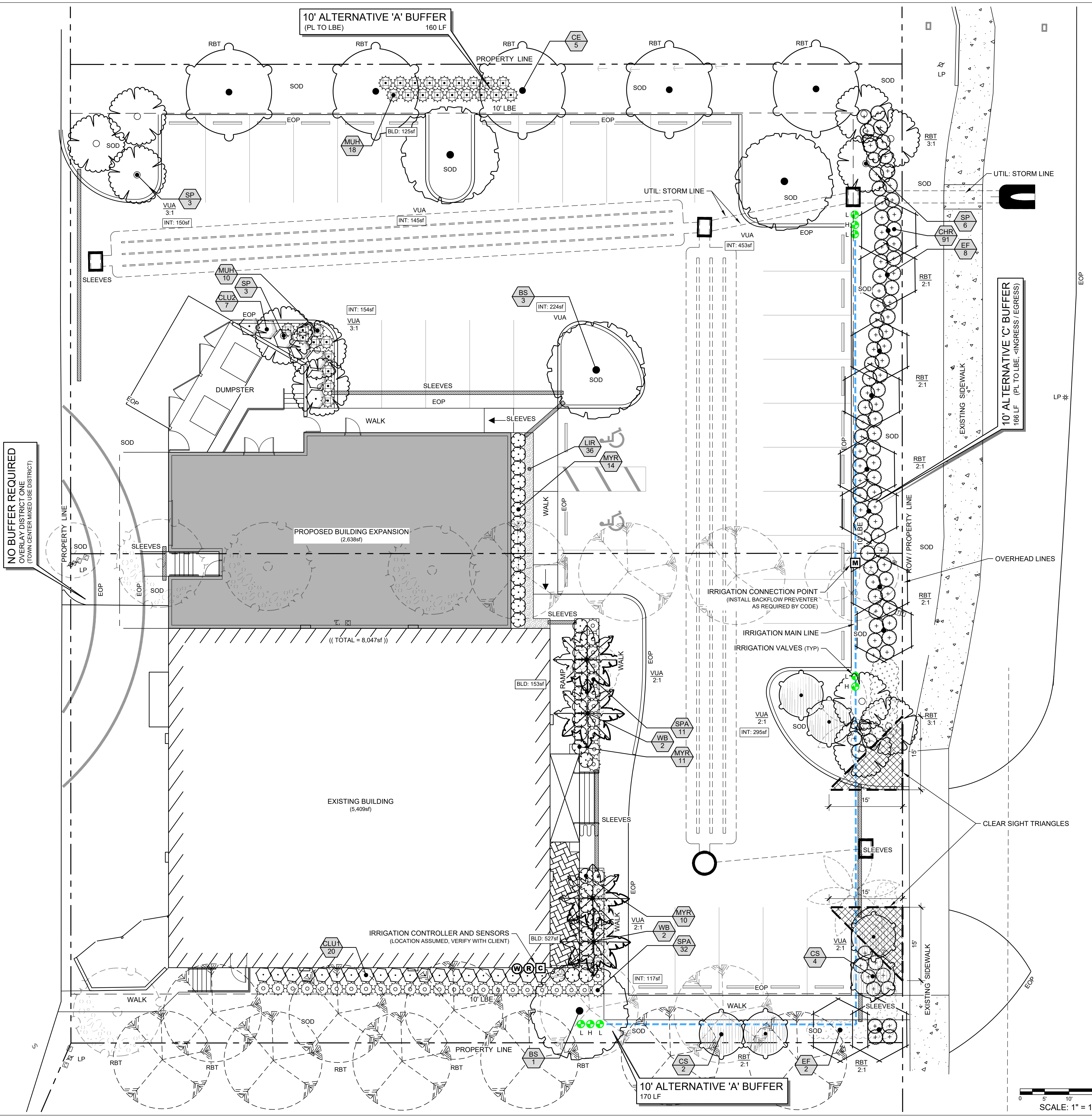

SCALE: 1" = 10'





**GradyMinor**  
Civil Engineers  
Landscape Architects  
Land Surveyors  
Planners

Bonita Springs 239.947.1144  
Fort Myers 239.690.4300

www.GradyMinor.com

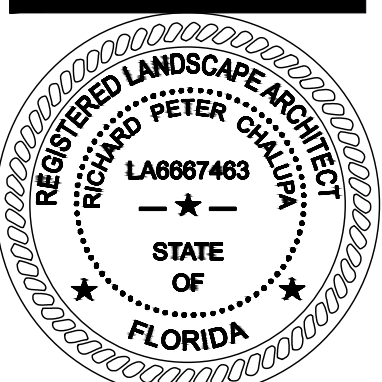

LANDSCAPE CALCULATIONS - CITY OF MARCO ISLAND, FL										
NO.	DESCRIPTION	MEASUREMENT	UNITS	CALCULATION	REQUIRED			PROVIDED		
					AMOUNT	UNIT	DESCRIPTION	AMOUNT	UNIT	DESCRIPTION
1.	VEHICULAR USE AREA (SECTION 30-439.b. c) AREA WITHOUT CURBING, LABELED AS "INT" AND "VUA"	15,382	sf	INTERIOR: sf x 0.10 TREES: 1 / 250sf	1,538	sf	INTERIOR LANDSCAPING	1,538	sf	INTERIOR LANDSCAPING
					9	qty	TREES	9	qty	TREES
2.	RIGHT-OF-WAY LANDSCAPING (SECTION 30-441.g) 10' ALTERNATIVE 'C' BUFFER, R.O.W.: BALD EAGLE DRIVE, LABELED AS "RBT"	166	LF	TREES: LF / 30	6	qty	TREES	6	qty	TREES
		156	LF	SHRUBS: LF / 3 x 2 (ADJACENT TO VUA)	104	qty	SHRUBS	104	qty	SHRUBS (91 PROPOSED + 13 EXISTING)
3.	PERIMETER BUFFERING (SECTION 30-441.g) 10' TYPE 'A' BUFFER, NORTH, LABELED AS "RBT"	160	LF	TREES: LF / 30	5	qty	TREES	5	qty	TREES
	10' TYPE 'A' BUFFER, SOUTH, LABELED AS "RBT"	170	LF	TREES: LF / 30	6	qty	TREES	6	qty	TREES (3 PROPOSED + 3 EXISTING)
4.	BUILDING PERIMETER PLANTINGS (SECTION 30-440.4) COMM. INSTITUTIONAL & MULTIFAMILY LABELED AS "BLD" AND "BPP"	8,047	sf	PLANTINGS @ 100sf / 1,000sf BLDG. Planting bed = 5' min. width	805	sf	PLANTING	805	sf	PLANTING
5.	LANDSCAPE REQUIREMENTS (SECTION 30-440.3) INSTITUTIONAL / COMMERCIAL: TREES: 1 / 3,000sf PERVIOUS AREA LABELED AS "RGT" (EXCLUDING PRESERVES)	8,590	sf	PERVIOUS sf / 3,000	3	qty	TREES (TOTAL MINIMUM, MAX: 15)	3+	qty	TREES

\* Vehicular Use Area, Required Trees - Based on the calculation on the square footage of pavement, the required number of canopy trees is 6.  
LDC Section 30-439.c requires a canopy tree at the terminal islands, therefore the minimum number of VUA trees is 9.

**PLANT SCHEDULE: SITE DEVELOPMENT PLAN**

SYMBOL	CODE	QTY	BOTANICAL NAME	COMMON NAME	HT. AND SPR.	CALIPER	SPEC.	NATIVE
<b>TREES</b>								
	BS	4	Bursera simaruba	Gumbo Limbo	12' ht. min. x 6' spd. min.	3" cal. min.	Full crown	Yes
	CE	5	Conocarpus erectus	Green Buttonwood	12' ht. min. x 6' spd. min.	3" cal. min.	Standard	Yes
	CS	6	Conocarpus erectus 'ser'	Silver Buttonwood	12' ht. min. x 6' spd. min.	3" cal. min.	Standard	Yes
	EF	10	Eugenia foetida	Spanish Stopper	12' ht. min. x 6' spd. min.	3" cal. min.	Standard	Yes
<b>PALMS</b>								
	SP	12	Sabal palmetto	Cabbage Palm	12' ct	Booted	Staggered heights, Tied Heads	Yes
	WB	4	Wodyetia bifurcata	Foxtail Palm	14' ct min.	Heavy	Straight trunk, Matching, Full Crown	No
SYMBOL	CODE	QTY	BOTANICAL NAME	COMMON NAME	SIZE	HT. AND SPR.	SPACING	NATIVE
<b>SHRUBS</b>								
	CHR	91	Chrysobalanus icaco 'RT'	Red Tip Cocoplum	3 gallon min.	24" ht. min.	36" oc	Yes
	CLU2	7	Clusia rosea 'PA'	Pitch Apple	10 gal. min.	48" ht., 36" spd.	48" oc	Yes
	CLU1	20	Clusia rosea 'PA'	Pitch Apple	3 gal. min.	36" ht min.	36" oc	Yes
	MUH	28	Muhlenbergia capillaris	Pink Muhly Grass	3 gallon min.	24" ht. min.	36" oc	Yes
	MYR	35	Myrcianthes fragrans	Simpson's Stopper	3 gallon min.	24" ht. min.	36" oc	Yes
	SPA	43	Spartina bakeri	Sand Cordgrass	3 gallon min.	24" ht. min.	36" oc	Yes
SYMBOL	CODE	QTY	BOTANICAL NAME	COMMON NAME	SIZE	HT. / SPR. / SPEC.	SPACING	NATIVE
<b>GROUND COVERS</b>								
	LIR	36	Liriope muscari 'EG'	Evergreen Giant Lilyturf	1 gal min.	12" ht.	18" oc	No

**SOD, MULCH and ROOT BARRIER**

SOD	TBD	SOD ALL PROPOSED SOD BEDS WITH STENOTAPHRUM SECUNDATUM - ST. AUGUSTINE FLORATAM SOD NOTED AS "SOD" ON PLAN.
BAHIA	TBD	ALL OTHER DISTURBED AREAS INCLUDING BUT NOT LIMITED TO RETENTION/DETENTION AREAS WITH PASPALUM NOTATUM - BAHIA - UNLESS OTHERWISE NOTED. CONTRACTOR SHALL CONFIRM SOD TYPE(S) AND VERIFY/SUBMIT QUANTITIES FOR AREAS THAT MAY BE UNIDENTIFIED AND/OR NOT LABELED ON PLAN.
MULCH	TBD	FORESTRY SERVICES COCO BROWN, OLD FLORIDA BLEND MULCH, OR APPROVED OTHER HARDWOOD MULCH NO CYPRESS MULCH PERMITTED SHREDDED, 3" THICK, ALL PLANT BEDS AND TREES RINGS (4") DIAMETER WITHIN SOD BEDS. CONTRACTOR TO VERIFY AND SUBMIT QUANTITIES.
ROOT	TBD	ROOT BARRIER TO BE INSTALLED AS NECESSARY. SEE DETAILS SHEET FOR INFORMATION. CONTRACTOR TO VERIFY AND SUBMIT QUANTITIES.

**BARGAIN BASKET MARCO ISLAND**  
LANDSCAPE CALCS & PLANT SCHEDULE  
MARCO ISLAND, FL

G:\LANDSCAPE\REV\LABB - BARGAIN BASKET\10-LANDSCAPE\LABB - SDP LADWG 10/22/2024 12:51 PM

REVISIONS

**SHEET**  
**3 OF 4**





**GradyMinor**  
Civil Engineers  
Landscape Architects  
Land Surveyors  
Planners

Bonita Springs 239.947.1144  
Fort Myers 239.690.4380

www.GradyMinor.com

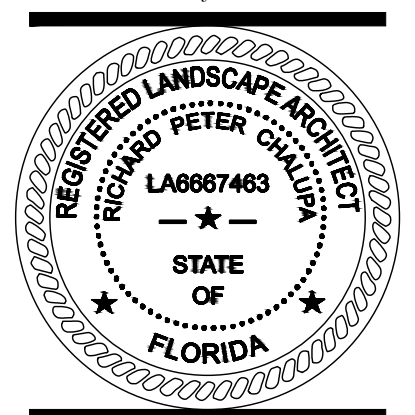

**LANDSCAPE INSTALLATION NOTES:**

- ALL PLANT MATERIAL MUST BE FLORIDA NO. 1.
- ALL PLANTS SHALL BE FERTILIZED WITH AGRIFORM 20-10-5 TABLETS AS PER THE MANUFACTURER'S SPECIFICATIONS IN CONJUNCTION WITH NOTE #3.
- THE PLANTING SOIL SHALL BE THE APPROXIMATE PROPORTIONS AS FOLLOWS: 50% SAND AND 50% ORGANIC MATERIAL CONSISTING OF NATIVE PEAT, WELL DECOMPOSED SAWDUST, LEAF MOLD AND TOP SOIL. IT SHALL PROVIDE A GOOD PLIABLE AND THOROUGHLY MIXED MEDIUM WITH ADEQUATE AERATION, DRAINAGE 1
- AND WATER-HOLDING CAPACITY. IT SHALL ALSO BE FREE OF ALL EXTRANEIOUS DEBRIS, SUCH AS ROOTS, STONES, WEEDS, ETC.
- A SET OF CONSTRUCTION DOCUMENTS AND/OR APPROVED CODE-REQUIRED PLANS SHALL BE ON SITE AT ALL TIMES.
- ALL UTILITIES, EASEMENTS, RIGHT-OF-WAY, OWNERSHIP, AND/OR OTHER SURVEY DATA SHALL BE VERIFIED BY THE GENERAL CONTRACTOR, SITE WORK CONTRACTOR, AND/OR LANDSCAPE CONTRACTOR PRIOR TO THE COMMENCEMENT OF WORK.
- COMPLIANCE / PERMIT ACQUISITION AND/OR DISPLAY IS REQUIRED FOR CODE-RELEVANT REQUIREMENTS (SUCH AS, BUT NOT LIMITED TO: REMOVALS, TRIMMING, REPLACEMENT, ETC.)
- VERIFY PLANT QUANTITIES AND SPECIFICATIONS WITH THE LANDSCAPE ARCHITECT (ALSO REFERENCED AS "L.A." HEREAFTER). NOTIFY THE LANDSCAPE ARCHITECT IMMEDIATELY IF DISCREPANCIES ARE NOTED. PLANTING PLAN SHALL TAKE PRECEDENCE OVER "PLANT LIST" QUANTITIES. THE L.A. RESERVES THE RIGHT FOR MATERIAL REJECTION IF THE INSTALLATION DOES NOT CORRESPOND TO THE "PLANT LIST" SPECIFICATION / REMARK.
- PLANT MATERIAL IS TO BE FLORIDA GRADE #1 MINIMUM AND FLORIDA FANCY FOR PLANT MATERIAL SPECIFIED AS "SPECIMEN" TREES ARE TO BE CONSIDERED SINGLE TRUNK AND MEET THE MINIMUM STANDARD FOR CODE WITHIN THE APPLICABLE JURISDICTION.
- SIZES/SPECIFICATIONS ARE CONSIDERED MINIMUM. INSTALLATION MATERIAL IS TO MEET OR EXCEED THESE REQUIREMENTS - VERIFY ANY DISCREPANCY PRIOR TO MATERIAL PURCHASE, DELIVERY, AND/OR INSTALLATION.
- THE LANDSCAPE CONTRACTOR SHALL VERIFY THE LOCATION OF PLANT MATERIAL WITH THE LANDSCAPE ARCHITECT PRIOR TO INSTALLATION - CONTACT THE L.A. FOR SPECIFIC GUIDELINES. IF A SITE CONFLICT / POTENTIAL IS NOTED, NOTIFY THE LANDSCAPE ARCHITECT PRIOR TO MATERIAL INSTALLATION. THE L.A. RESERVES THE RIGHT FOR MATERIAL RELOCATION IF THE INSTALLATION DOES NOT CORRESPOND TO THE PLANTING PLAN.
- THE LANDSCAPE CONTRACTOR AND/OR IRRIGATION CONTRACTOR SHALL BE RESPONSIBLE FOR DAMAGED SITE UTILITIES, INFRASTRUCTURE, ETC. REPAIR / REPLACE SHALL BE A REQUIREMENT.
- VERIFY SITE REMOVALS, RELOCATIONS, AND/OR PROTECTED ITEMS PRIOR TO BID PREPARATION. THIS MAY INCLUDE BUT NOT BE LIMITED TO: SOD, SOIL, PLANT MATERIAL, STUMPS, ETC. THE LANDSCAPE CONTRACTOR SHALL BE REQUIRED TO COMPLETE WORK AS OUTLINED WITH THE PLANTING PLAN(S), SPECIFICATIONS, AND NOTES.
- QUANTITIES AND SPECIFICATION ARE SUBJECT TO ADJUSTMENT, RELOCATION, AND/OR REMOVAL DURING OR AFTER THE INSTALLATION AND SUBSEQUENT APPROVAL PROCESS BY THE L.A.
- CONTRACTOR AND / OR LANDSCAPE CONTRACTOR SHALL REMOVE ALL PROHIBITED EXOTIC(S) OR NUISANCE PLANTS AND IT SHALL BE MAINTAINED FREE OF EXOTICS IN PERPETUITY AS DEFINED BY THE LOCAL AGENCY(IES) WHICH SHALL SUPERCEDE STATE REQUIREMENTS; HOWEVER, THE FLORIDA EXOTIC PEST PLANT COUNCIL (FLEPPC) AND/OR UF-IFAS STANDARDS SHALL BE USED AS A DATABASE TO JUSTIFY REMOVALS IF NO LOCAL ORDINANCE/CODE REQUIREMENT EXISTS.
- THE LANDSCAPE CONTRACTOR SHALL EXECUTE PRUNING VIA A CERTIFIED ARBORIST AND USING STANDARDS AS ESTABLISHED BY THE INTERNATIONAL SOCIETY OF ARBORICULTURE. ALL PRUNING, UPON REQUEST, SHALL BE ADVISED BY THE L.A.
- TREES AND PALMS OVER 9' IN HEIGHT SHALL BE STAKED.
- THE LANDSCAPE CONTRACTOR AND/OR IRRIGATION CONTRACTOR SHALL BE RESPONSIBLE FOR:
  - PLANT WARRANTIES AND REPLACEMENTS, AS SPECIFIED WITHIN THEIR RESPECTIVE AGREEMENT(S)
  - PLANT MATERIAL MAINTENANCE UNTIL "SUBSTANTIAL COMPLETION"
  - PLANT MATERIAL PROTECTION ADEQUACY
  - SCOPE OF WORK VERIFICATION AND EXECUTION
  - COORDINATION OF ALL SUBCONTRACTOR(S)
  - THE OWNER / GENERAL CONTRACTOR SHALL BE RESPONSIBLE FOR: 1- PROVIDING FINAL GRADE, SITE ACCESS, SECURITY OF THE SITE 2- CONTRACT REVIEW AND ACCEPTANCE OF TERMS 3- PLANT / IRRIGATION MAINTENANCE COORDINATION 4- PAYMENT MILESTONES.
- IRRIGATION SYSTEM REQUIRES BACK FLOW PREVENTION. ASSURE EXISTING BACK FLOW PREVENTION IS FUNCTIONAL AND/OR INSTALL A NEW BACK FLOW PREVENTION PER COUNTY REQUIREMENTS. CONTRACTOR SHALL FIELD VERIFY SIZE AND LOCATION.
- SOIL IN LANDSCAPE AREAS SHALL BE UNIFORM QUALITY. FREE FROM HARD CLODS, STIFF CLAY, HARD PAN, SODS, PARTIALLY DISINTEGRATED STONE, LIME, CEMENT, ASHES, SLAG, CONCRETE, TAR RESIDUES, TARRED PAPER, BOARDS, CHIPS, STICKS OR ANY OTHER UNDESIRABLE MATERIAL. IN NO CASE SHALL THERE BE MORE THAN 5% BY VOLUME OF STONES, COARSE SAND, GRAVEL OR CLAY LUMPS LARGER THAN ONE INCH (1") IN DIAMETER.

**GENERAL SDP NOTES:**

- ALL PLANT MATERIAL MUST BE FLORIDA NO. 1.
- MINIMUM 3" LAYER OF MULCH (AFTER WATERING IN) REQUIRED. 4' RADIUS TREE RING FROM TRUNK. NO CYPRESS MULCH.
- BERMS FOR GRASS STABILIZED: MAX. 4:1 SLOPE. FOR GROUND COVER STABILIZED: 3:1 MAX. WITH THE TOE OF THE SLOPE SET BACK 5' FOR THE EDGE OF R.O.W./PROPERTY LINES. BERMS ARE PERMITTED IN EASEMENTS PROVIDED WRITTEN APPROVAL RECEIVED FROM ALL INTERESTS UNDER SAID EASEMENT. BERMS ADJACENT TO I-75 HAVE EXEMPTIONS TO THESE REQUIREMENTS.
- STAKING RE-STAKED WITHIN 24 HOURS OF A BLOW OVER / STAKING FAILURE. REMOVE BETWEEN 6 AND 12 MONTHS AFTER PLANTING.
- LIGHT POLE STAKES MIN. 12" 5' FROM TRUNKS.
- EASEMENTS WRITTEN PERMISSION MUST BE OBTAINED FOR ANY PLANTING.
- LIMEROCK SHALL BE EXCAVATED FROM PLANTING HOLES / PLANTING AREAS IN PARKING LOTS.
- MAINTENANCE SHALL ABIDE BY ALL CODES. REMOVALS SHALL BE VERIFIED WITH PERTINENT CODES, SURVEYS, PER MITS, ETC. PRIOR TO ACTION.
- IRRIGATION 100% COVERAGE REQUIRED. TIMERS WITH AUTOMATIC OVERRIDES FOR RAIN. SEPARATE ZONING IS REQUIRED FOR DIFFERENT WATER USE AREAS, AND WATERING WITHIN GUIDELINES ESTABLISHED BY THE SFWMD AND/OR LOCAL MUNICIPALITY.
- PLANTINGS MUST BE A MINIMUM OF 24" FROM THE BACK OF CURB.

**IRRIGATION NOTES:**

- THE SITE IS TO CONTAIN 100% IRRIGATION COVERAGE VIA AN EFFICIENT SYSTEM UTILIZING STANDARDS COMMON TO THE INDUSTRY.
- THE IRRIGATION SYSTEM IS TO BE CONTROLLED BY A RAIN AND/OR WIND SENSOR SWITCH CONNECTED TO THE SYSTEM CONTROLLER. THE LOCATION OF THE SYSTEM CONTROLLER IS TO BE VERIFIED AND COORDINATED AS NECESSARY TO PROVIDE ACCESS AND ELECTRICAL CONNECTION(S).
- VERIFY PUMP AND EQUIPMENT LOCATIONS WITH OWNER.
- IRRIGATION SLEEVING LOCATIONS INDICATED ARE DIAGRAMMATIC AND SERVE ONLY AS A GUIDE FOR INSTALLATION PURPOSES. IRRIGATION SLEEVING IS TO BE A MINIMUM OF SCHEDULE 40 PVC TWO TIMES THE SIZE OF IRRIGATION PIPE. THIS WORK IS TO BE COORDINATED BY THE GENERAL CONTRACTOR. SLEEVING SHALL BE CLEARLY MARKED, FLAGGED, OR OTHERWISE DELINEATED ABOVE GRADE TO AVOID DAMAGE AND PROVIDE EASE OF LOCATION FOR FUTURE USE. SLEEVING SHALL BE UTILIZED IN AREAS WHERE PIPING MUST CROSS A GREATER THAN 5" WIDTH, SUCH AS ROADS AND WALKS.
- IRRIGATION CONTRACTOR TO VERIFY ALL SLEEVING LOCATIONS WITH THE OWNER / DEVELOPER / GENERAL CONTRACTOR PRIOR TO INSTALLATION OF ALL SUBSURFACE AND PROPOSED IMPERVIOUS SURFACES. THIS IRRIGATION PLAN IS CONCEPTUAL FOR CODE MINIMUM PURPOSES AND WILL NEED FURTHER DETAILING UPON FINALIZING CONTRACTS FROM A SELECTED IRRIGATION DESIGNER / LANDSCAPE ARCHITECT OF CHOICE.
- AVOID OVERSPRAY ON PAVEMENT, BUILDINGS, ETC. UTILIZE PRESSURE-COMPENSATING HEADS FOR ELIMINATION OF AEROSOL SPRAY (THIS IS A STANDARD FEATURE OF INST. HUNTER SPRAY HEADS).
- THE DESIGN IS BASED UPON THE FOLLOWING OPERATING PARAMETERS: 60 GPM MAX. AND 40 PSI MIN.-60 PSI MAX.
- PIPE SIZING SHALL BE DETERMINED BY THE FRICTION LOSS METHOD AND WATER VELOCITY SHALL NOT EXCEED 5 CUBIC FEET PER SECOND.
- CONSTANT PRESSURE PIPING SHALL BE SCH 40 PVC.
- THE IRRIGATION CONTRACTOR SHALL SUPPLY AS-BUILT DRAWINGS AND MATERIAL CUT SHEETS UPON INSTALLATION COMPLETION AND AS A TERM OF FINAL ACCEPTANCE. THIS COST SHALL BE ACCOMMODATED IN THE BID.
- ZONES SHALL BE MARKED IN THE CONTROLLER BOX AND CORRESPONDING VALVES SHALL HAVE AFFIXED TO THE VALVE COVER A WATERPROOF, FADE-RESISTANT TAG.
- VERIFY INSTALLATION AND PARTS WARRANTY PRIOR TO CONTRACT EXECUTION.
- IRRIGATION HEADS IN PLANTING BEDS SHALL BE 12" POP-UP MINIMUM AND 6" POP-UP MINIMUM IN SOD AREAS. RISERS, IF INSTALLED, SHALL BE BLACK PVC CONSISTENT WITH LATER PIPING. VERIFY REMAINING TYPE(S), IF NECESSARY. INSTALL QUICK COUPLERS AS REQUIRED OR AS NOTED.
- THIS SYSTEM SHALL BE AUTOMATED. PROVIDE A MOISTURE SENSING DEVICE, AND WILL AVOID THE APPLICATION (OR INDIRECT RUNOFF OF IRRIGATION WATER) OF WATER TO IMPERVIOUS AREAS.
- THIS SYSTEM SHALL UTILIZE BUBBLERS ON THE REQUIRED TREES.
- THE IRRIGATION METER IF REQUIRED SHALL BE SUPPLIED BY THE GENERAL CONTRACTOR.
- IRRIGATION SYSTEM REQUIRES BACK FLOW PREVENTION. ASSURE EXISTING BACK FLOW PREVENTION IS FUNCTIONAL AND/OR INSTALL A NEW BACK FLOW PREVENTION PER COUNTY REQUIREMENTS. CONTRACTOR SHALL FIELD VERIFY SIZE AND LOCATION.
- IRRIGATION LINES, HEADS, AND COMPONENTS SHALL NOT BE INSTALLED WITHIN THE ROW WITHOUT A COUNTY APPROVED LANDSCAPE MAINTENANCE AGREEMENT (LMA).
- PER DEPARTMENT OF HEALTH 64E-9.004 (E.) LANDSCAPE IRRIGATION WATER THAT WETS THE WET DECK AREA OF THE POOL, THE POOL ITSELF, ENTERS THE COLLECTOR TANK, OR WETS AN INTERACTIVE WATER FEATURE MUST BE POTABLE WATER FROM A PUBLIC WATER SYSTEM OR SHALL MEET THE BACTERIOLOGICAL QUALITY OF POTABLE WATER AS EVIDENCED BY ANNUAL LABORATORY ANALYSIS SUBMITTED TO THE DEPARTMENT. RECLAIMED WATER MAY NOT BE USED IN THESE AREAS. IF RECLAIMED WATER IS USED IN THE VICINITY OF THE POOL (INSIDE OF THE POOL FENCE OR WITHIN 100 FEET OF THE POOL WATER'S EDGE) IT MUST EMPLOY DRIP IRRIGATION OR SOAKER HOSES. SIGNS SHALL BE POSTED NOTIFYING POOL PATRONS THAT RECLAIMED WATER IS IN USE, AND IS NOT TO BE CONSUMED.
- ALL TURF AREAS CONSISTING OF ST. AUGUSTINE, ZOYSIA, OR BERMUUDA GRASS LABELED AS "SOD" SHALL BE IRRIGATED. ALL RETENTION, DETENTION, AND/OR AREAS LABELED AS "BAHIA" ON THE PLAN DO NOT REQUIRE IRRIGATION UNLESS OTHERWISE SPECIFIED.

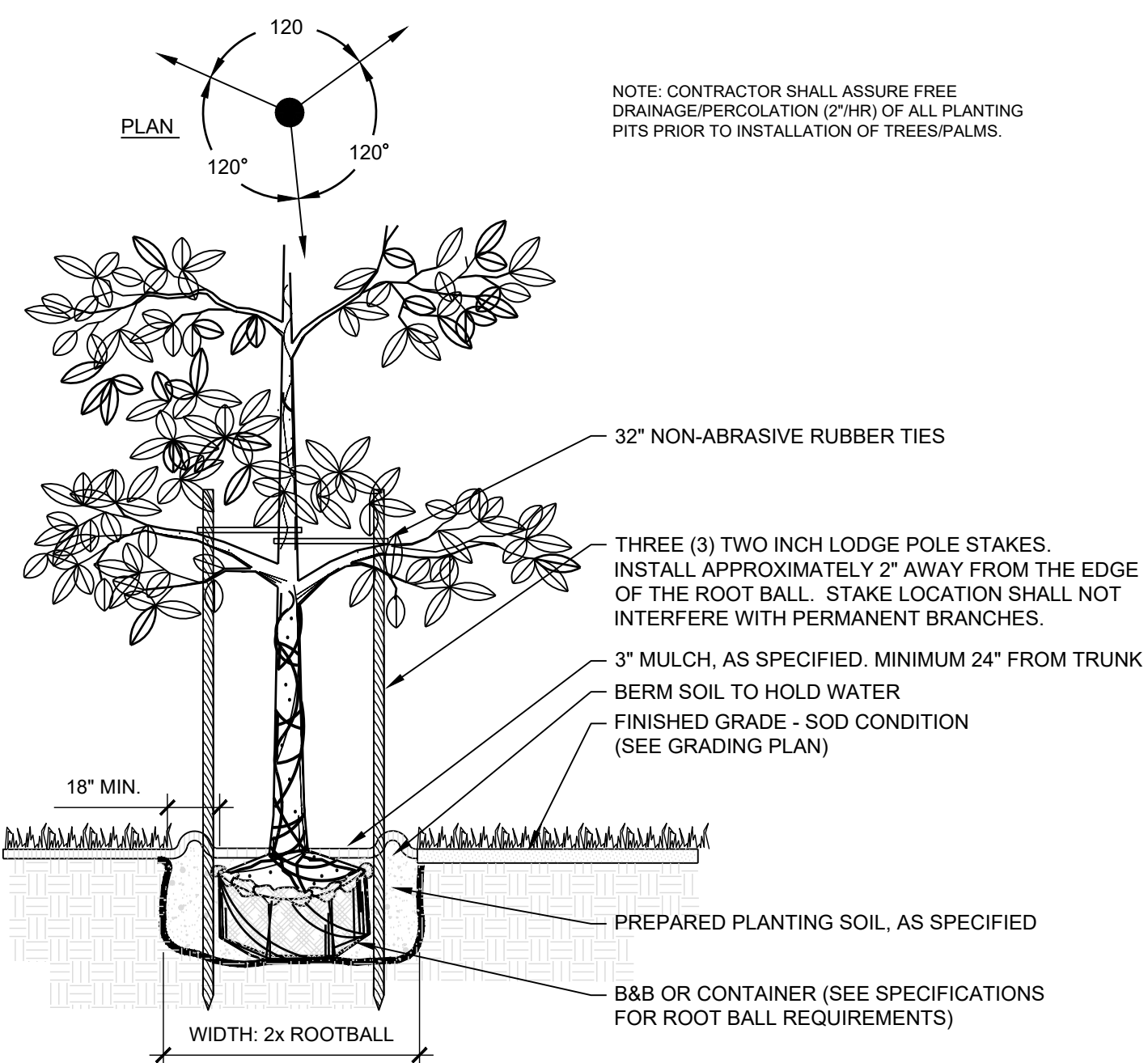

**TREE STAKING - LODGE POLES (3)**

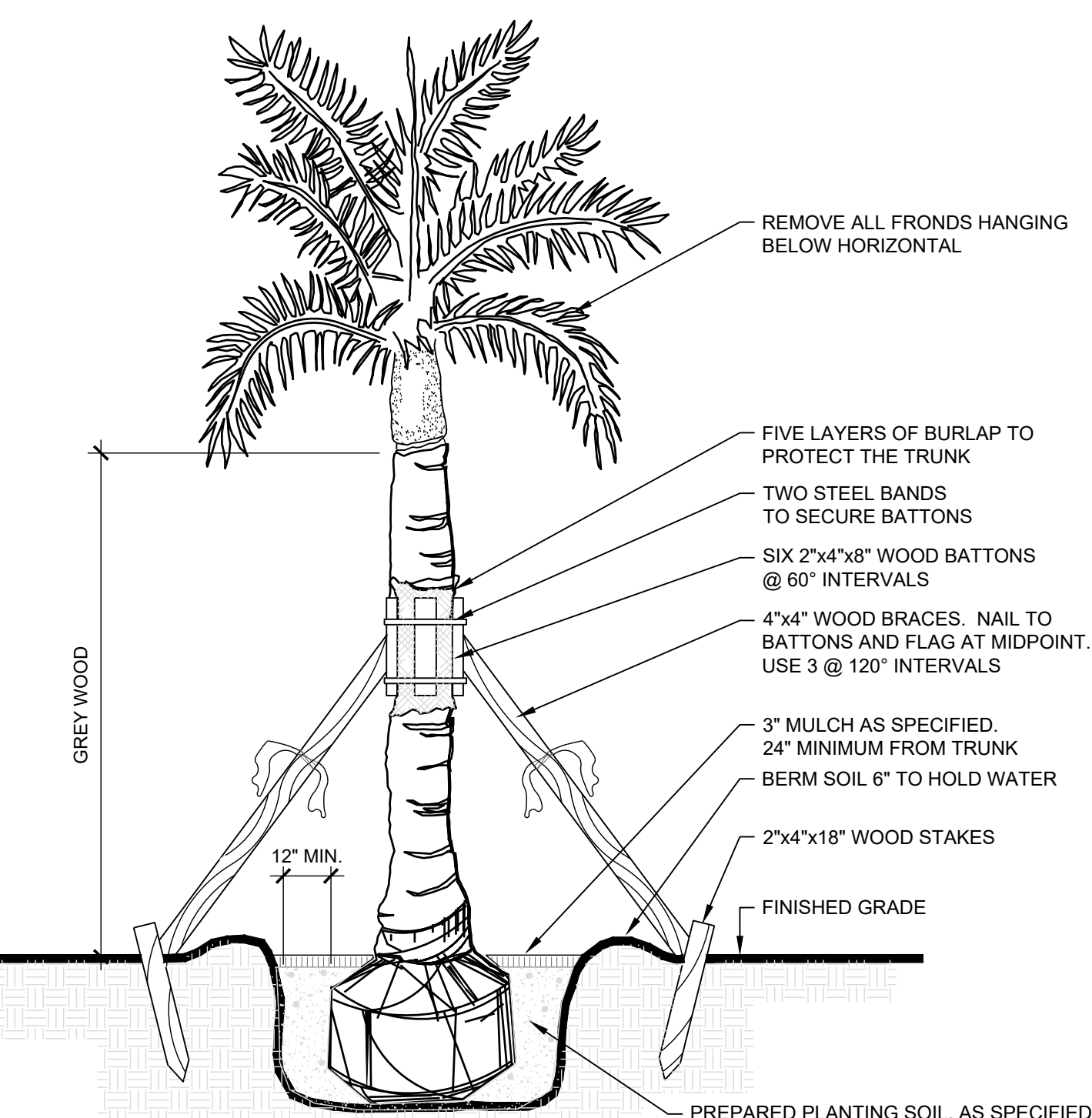

**PALM STAKING DETAIL**

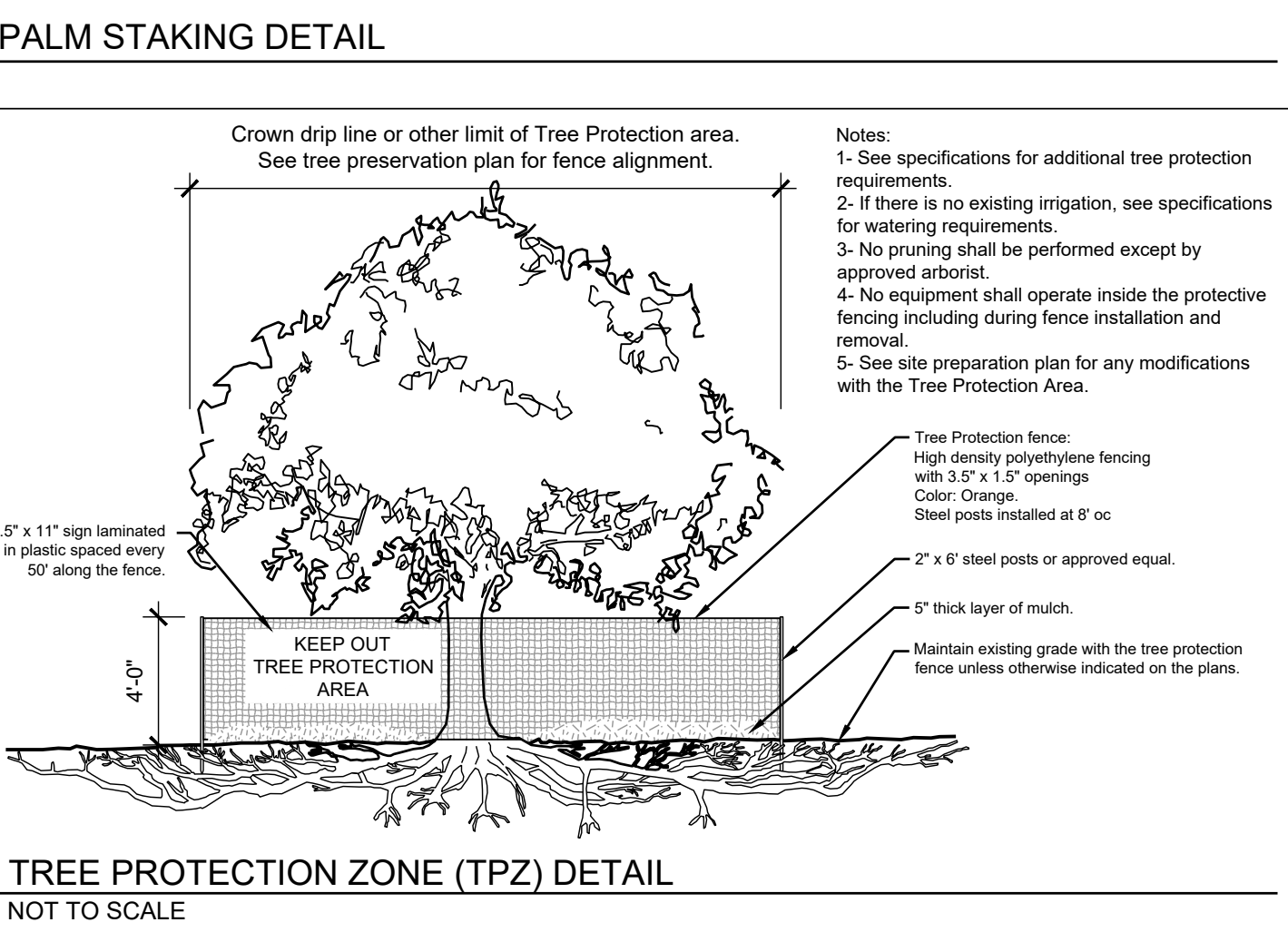

**TREE PROTECTION ZONE (TPZ) DETAIL**

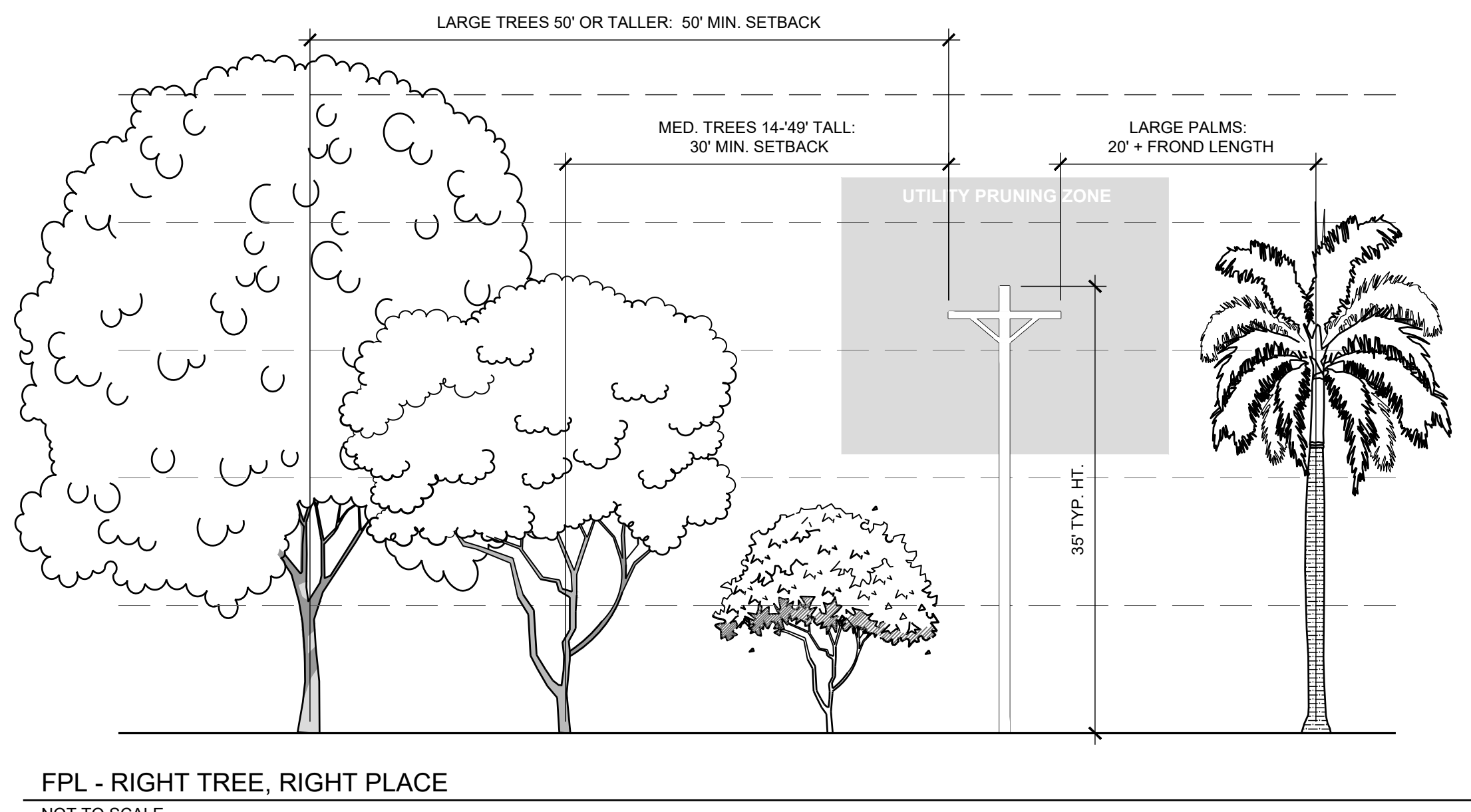

**FPL - RIGHT TREE, RIGHT PLACE**

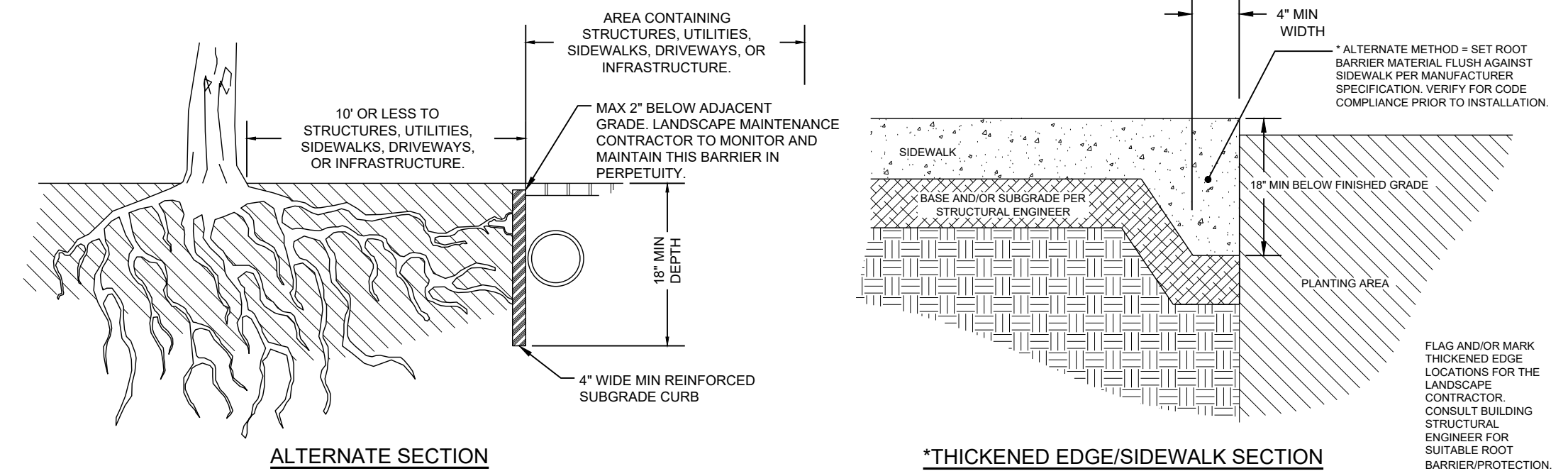

**REQUIRED: ROOT BARRIER DETAIL**

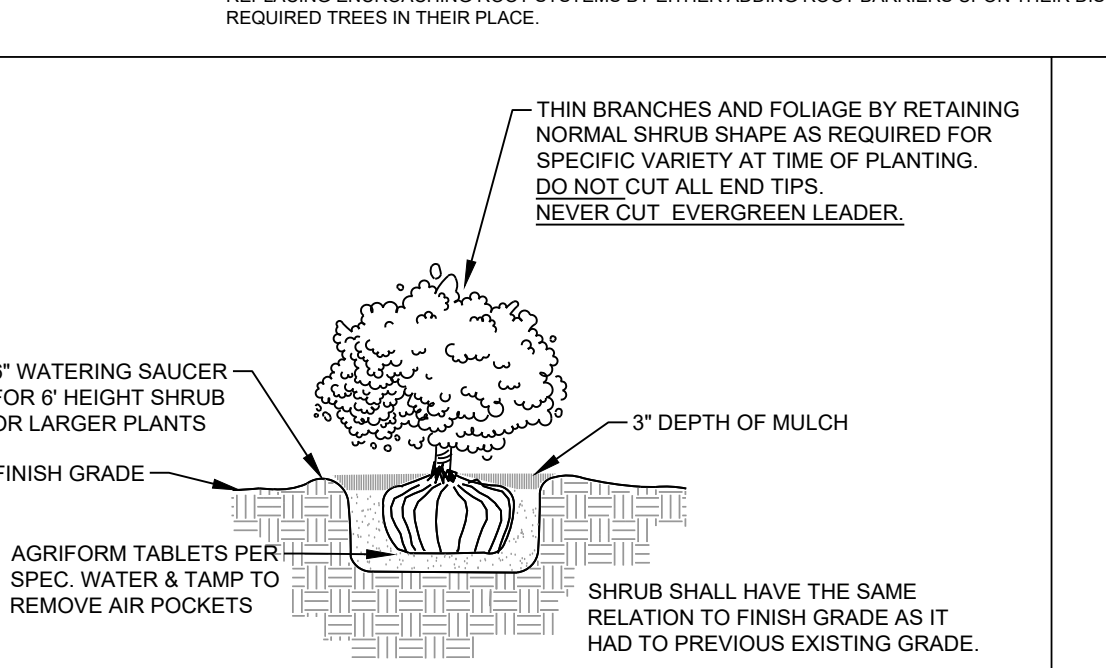

**LARGE SHRUB PLANTING DETAIL**

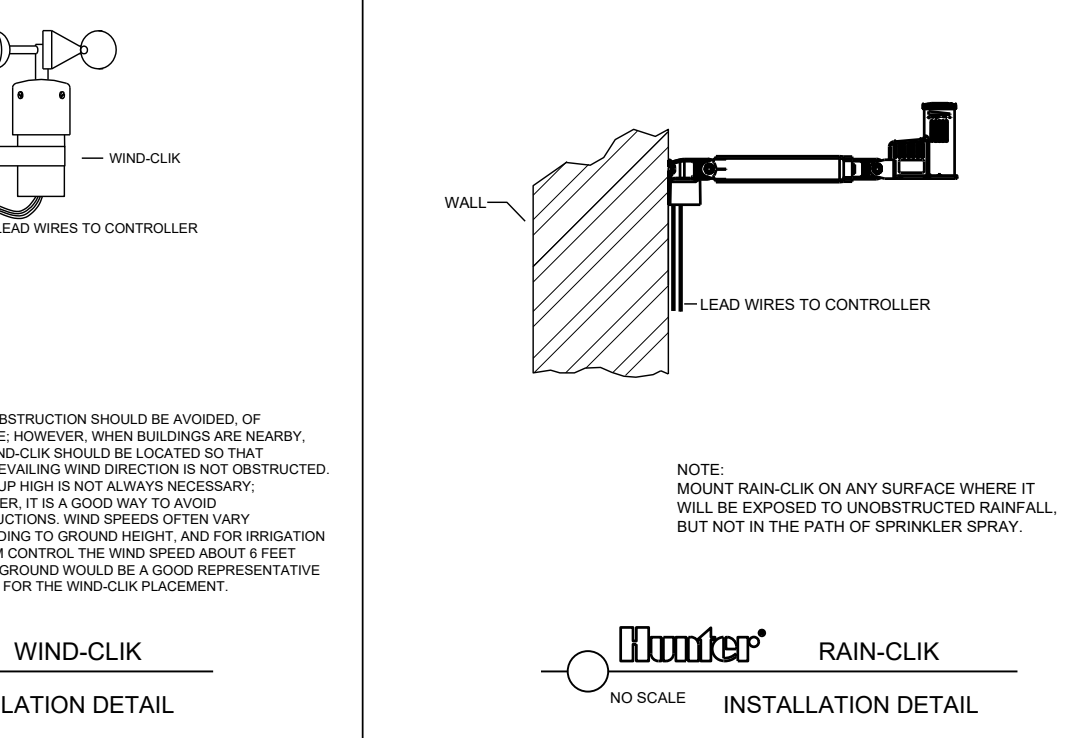
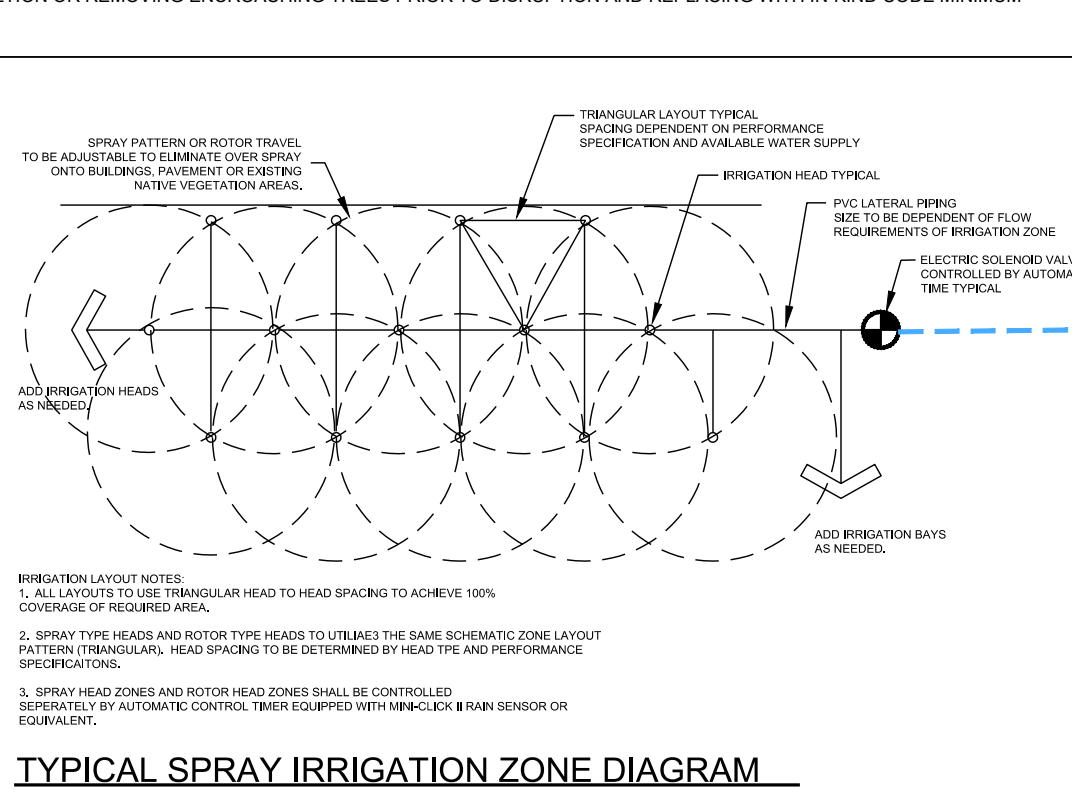

**WIND-CLIK RAIN-CLIK**

**BARGAIN BASKET MARCO ISLAND**  
DETAILS SHEET  
MARCO ISLAND, FL

REVISIONS